

Propuesta morfotipológica de las producciones cerámicas de Valencina de la Concepción a partir de la secuencia calcolítica del gran foso del corte A. Campaña de 1975

MORPHOTYOLOGICAL PROPOSAL OF THE VALENCINA DE LA CONCEPCIÓN CERAMIC PRODUCTIONS BASED ON THE CHALCOLITHIC SEQUENCE OF THE BIG DITCH OF STRATIGRAPHIC SECTION A. THE 1975 CAMPAIGN

ANEXO: LÁMINAS QUE RECOGEN LOS MATERIALES CERÁMICOS PROCEDENTES DEL CORTE A



Lámina I





Lámina III

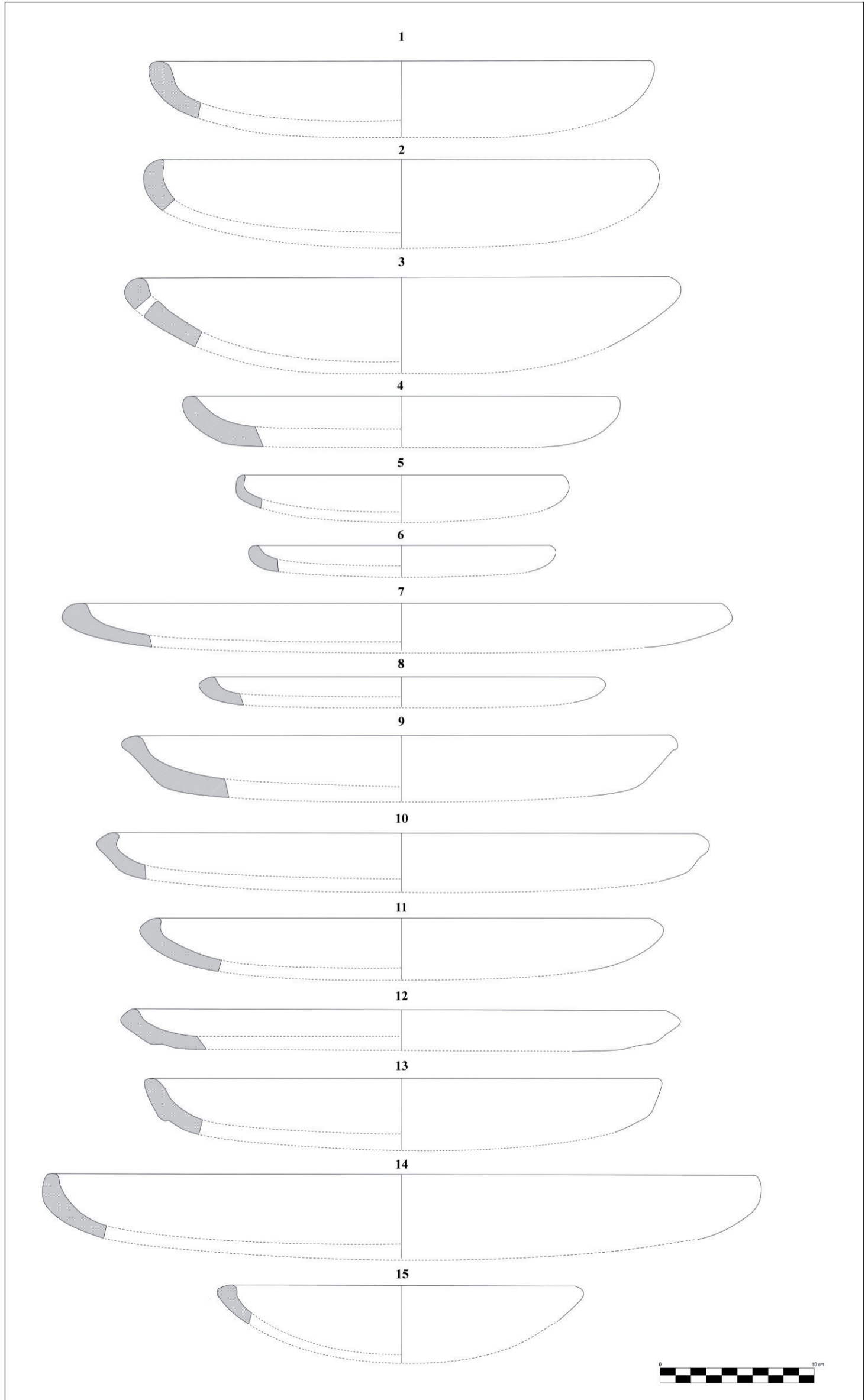
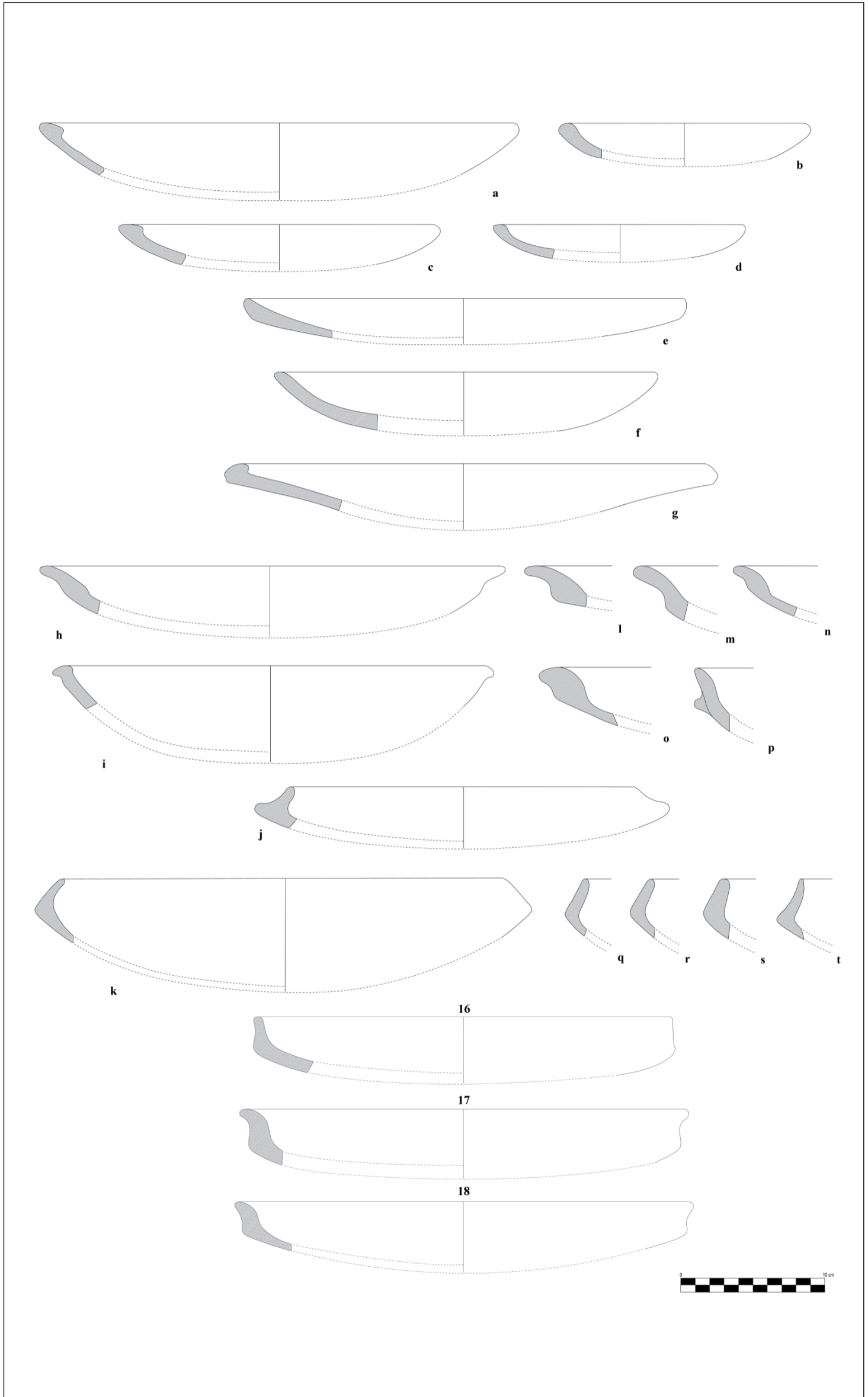

Lámina IV

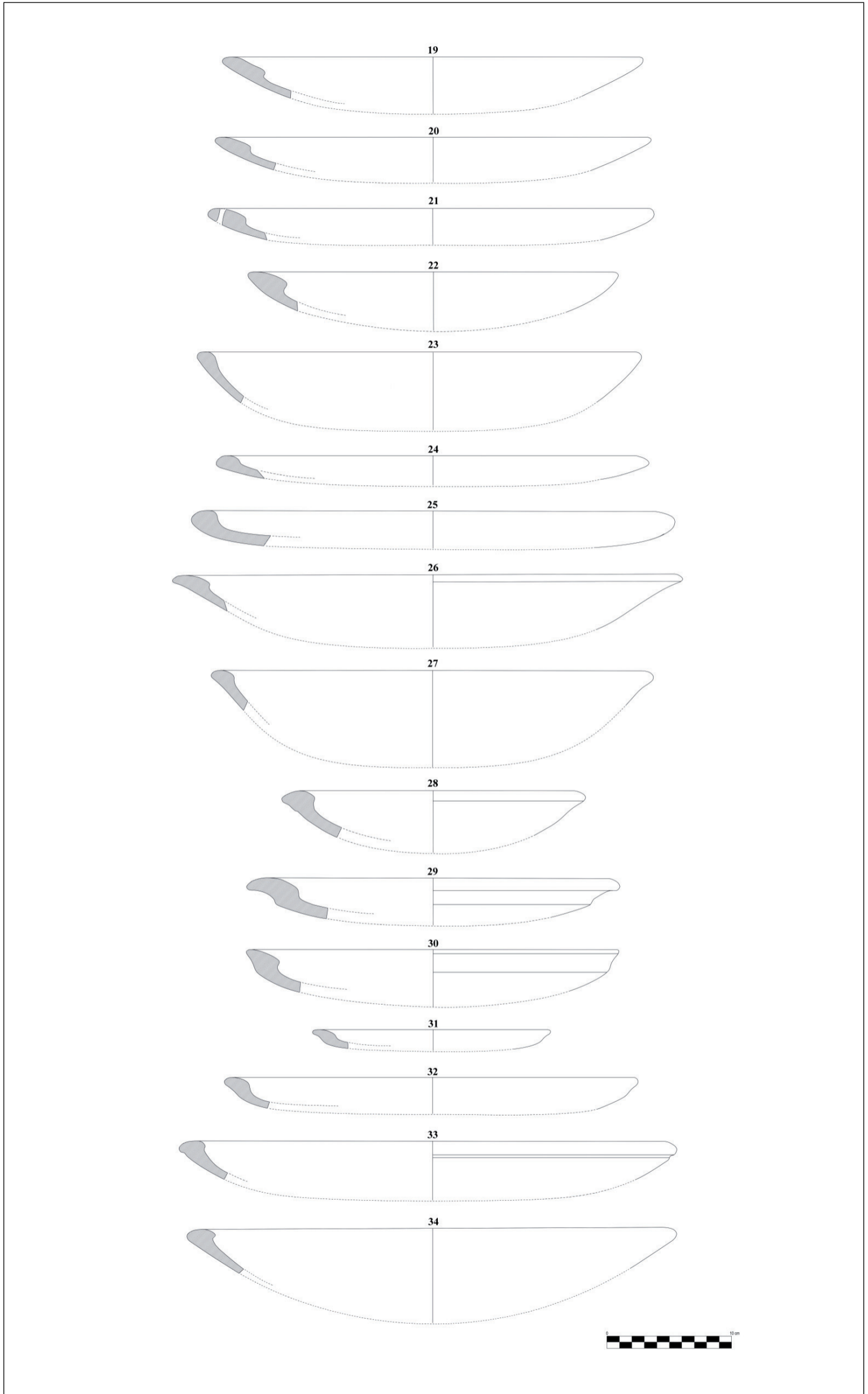

Lámina V

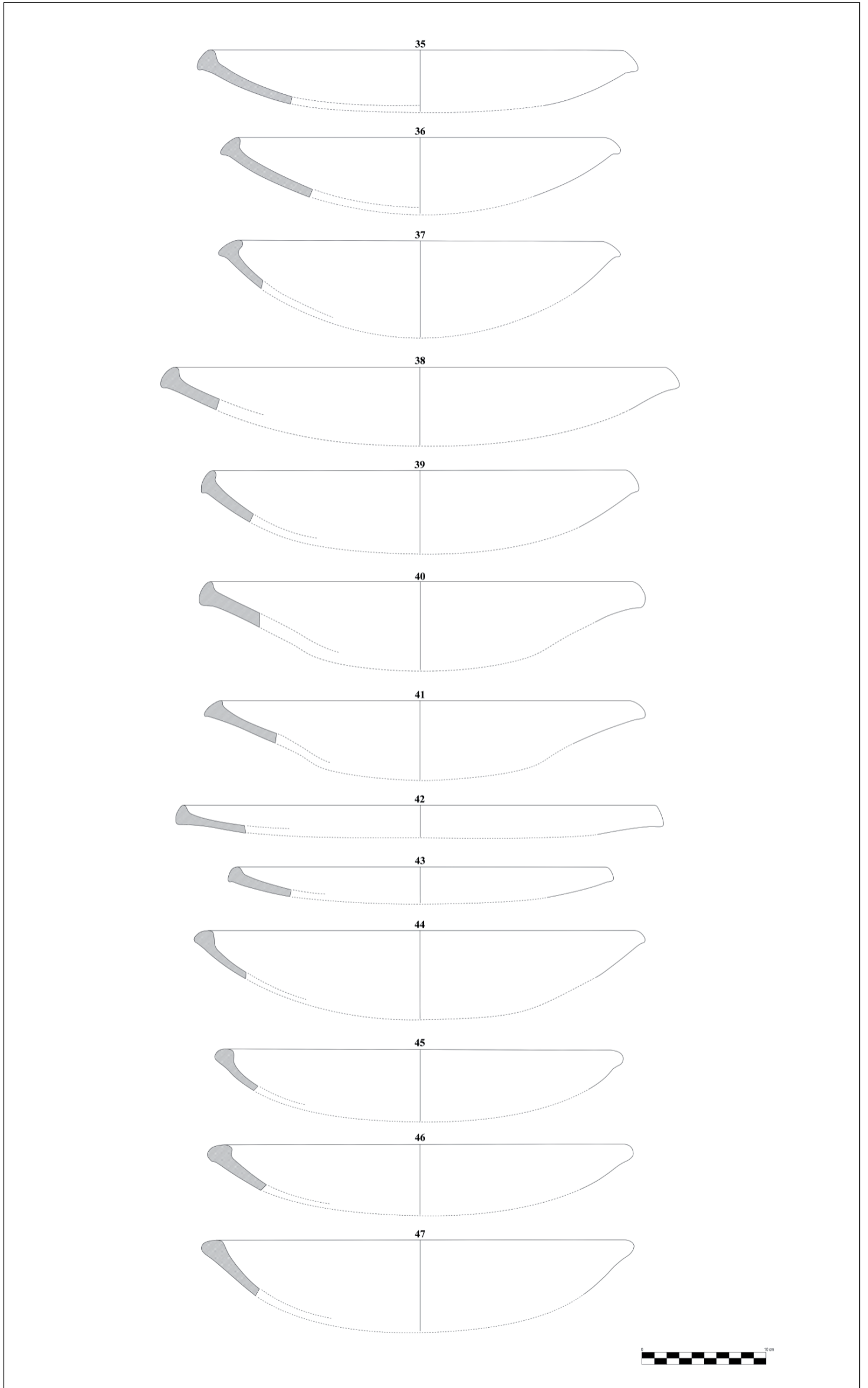

Lámina VI

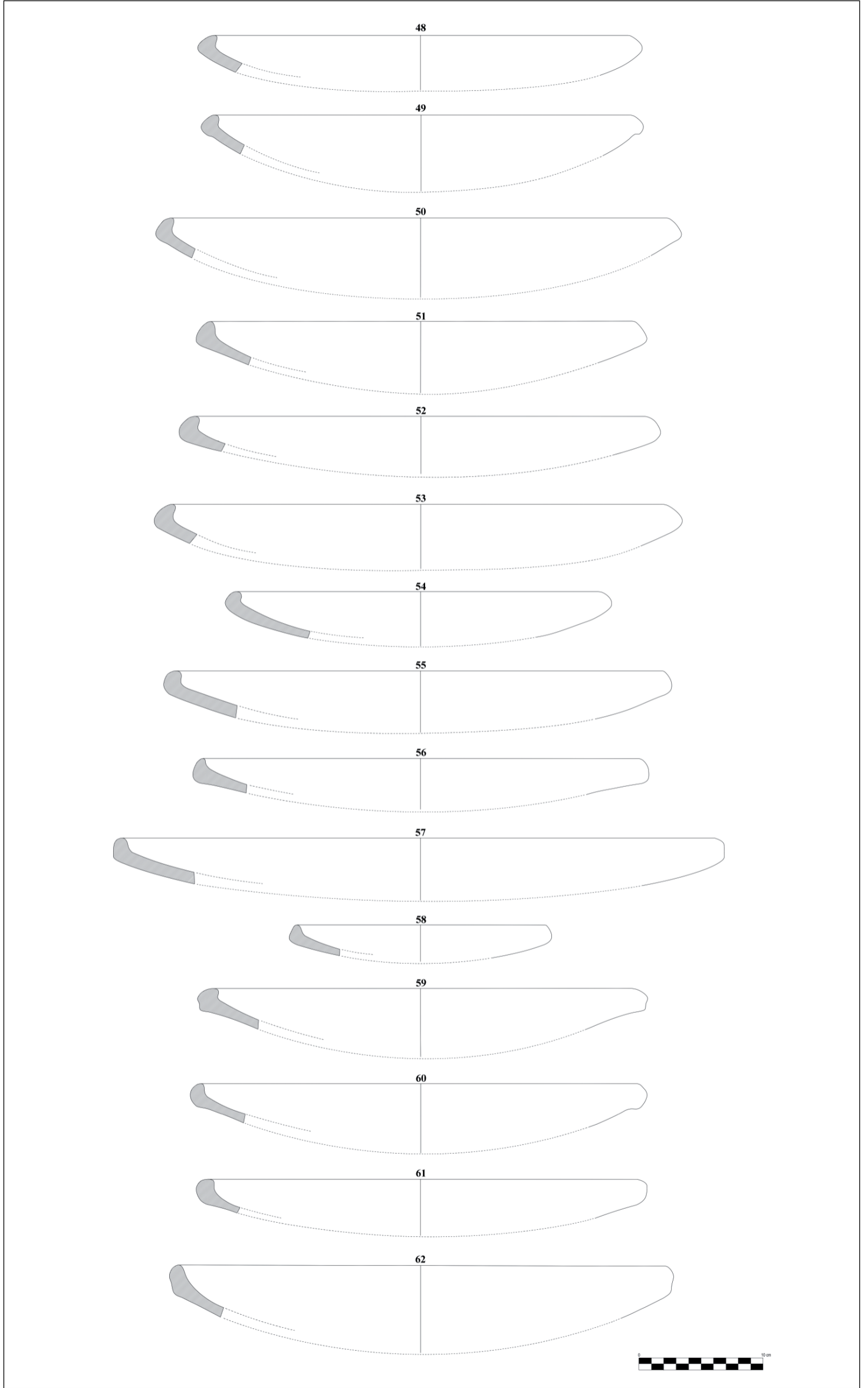

Lámina VII

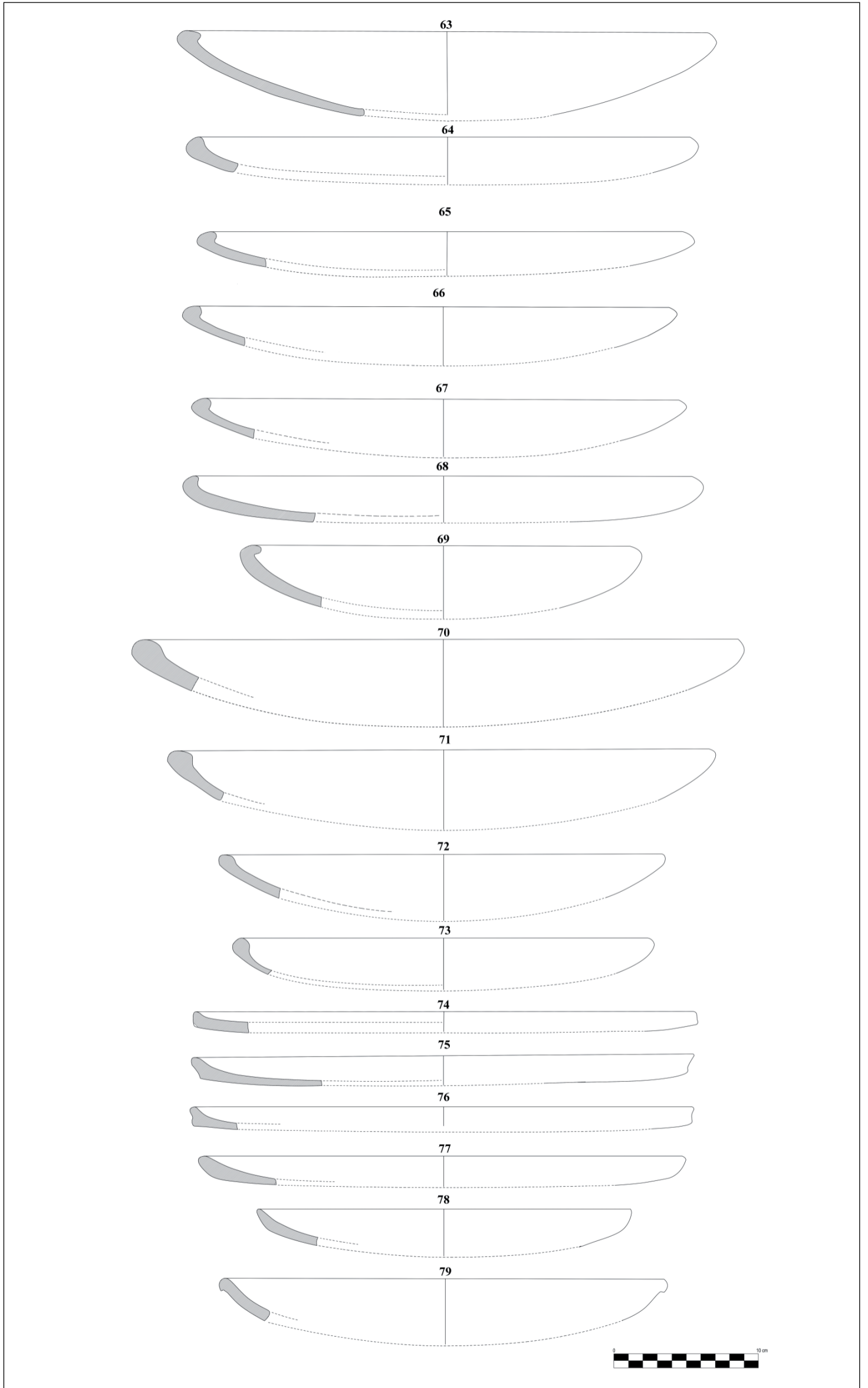
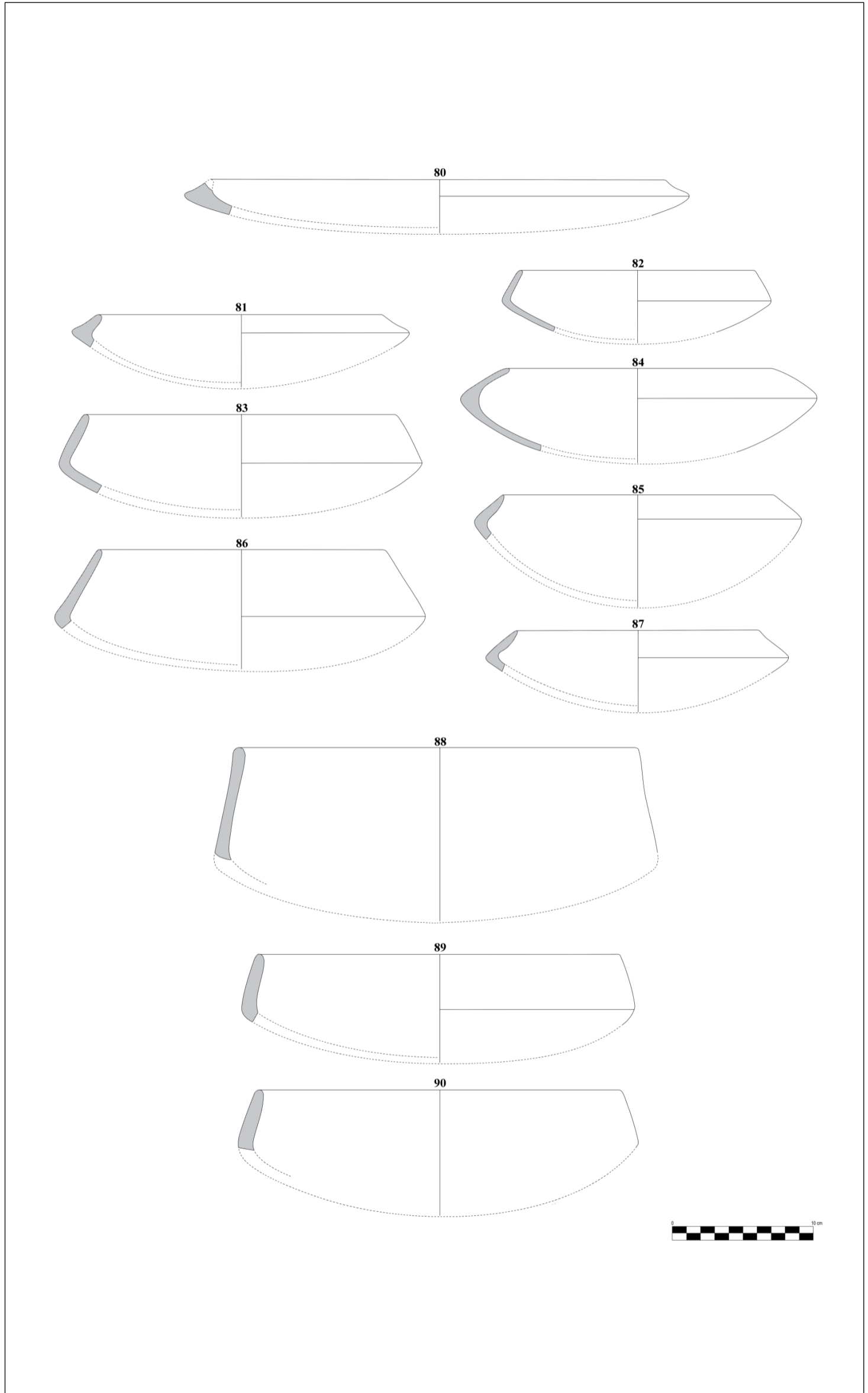